

4150008 HANGING PENDANT

Dimensions (as shown): 22" Dia x 29.5"H

Materials: Cast Aluminum, Spun Steel

Socket: (1) E26

Voltage: 120v

Suspension: Includes 8' chain

Custom sizing, lamping options, and voltages available. Please contact BDL for additional information.

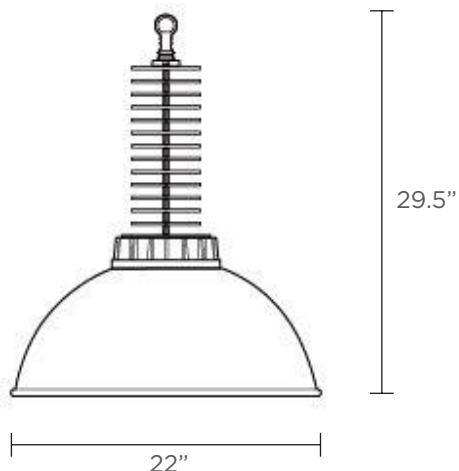

Cast aluminum finish options:

Natural or Polished

Plated finishes available (*upcharge applies*)

Spun steel shade options:

Any Color, Polished or Satin finish